

2021 College of Design Research & Creative Scholarship Showcase

"Carbon Sequestration Potential From Emerging MOF Technology"

Jordan Hedlund 02/12/2021

M.O.F. EXPERIMENTAL PLANTING BEDS

Metallic Organic Frameworks (MOF) is a new emerging technology that leverages the power of naturally occurring high energy reactions of atomic metal structures. As our understanding of these structures has grown we can use them to extract certain chemicals from the air and water at very high concentrations and efficiencies. The molecules that get attracted are called “guest molecules” and depending on the MOF, different guest molecules can be harvested.

The specific MOF being proposed for this project is one called a Porous Coordination Polymer (PCP) and it uses Zinc to attract carbon atoms out of air. The molecules arrange on a substrate via an epoxy layer in a form similar to a series of fan blades. As air moves through the substrate, the “fans” trap CO₂ until it becomes very concentrated on the surface. The Epoxy is removed and through a series of heat, pressure, and centrifuging the carbon is separated. From there polyurethane can be made and be used in the manufacturing process.

What makes this type of MOF so appealing is that not only can the epoxy be applied to almost any type of structure, but it could possibly be 10x more efficient at collecting carbon than other MOF's, and the epoxy can be reused without depletion of the carbon yield.

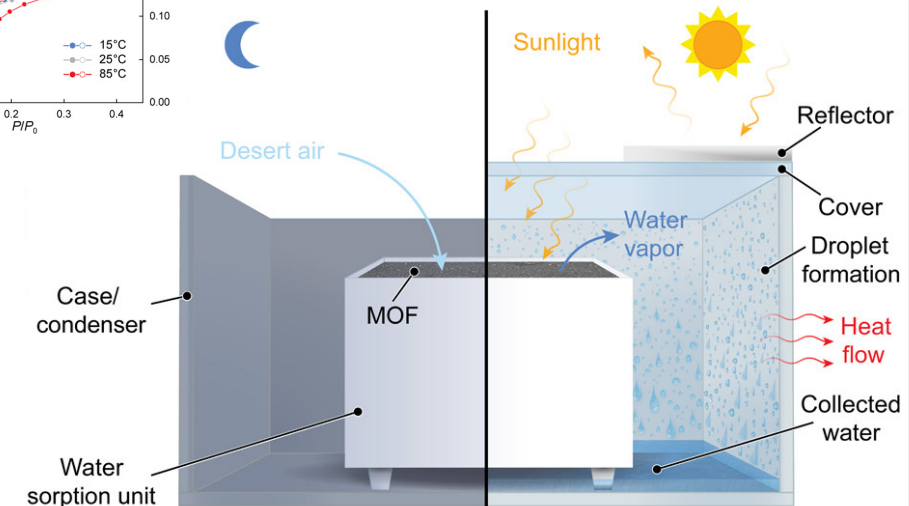
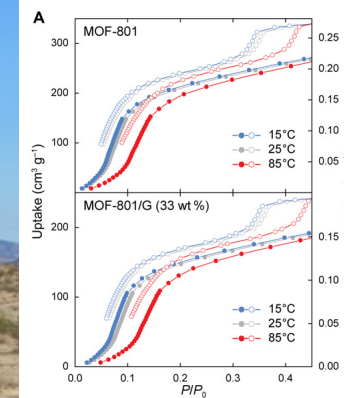
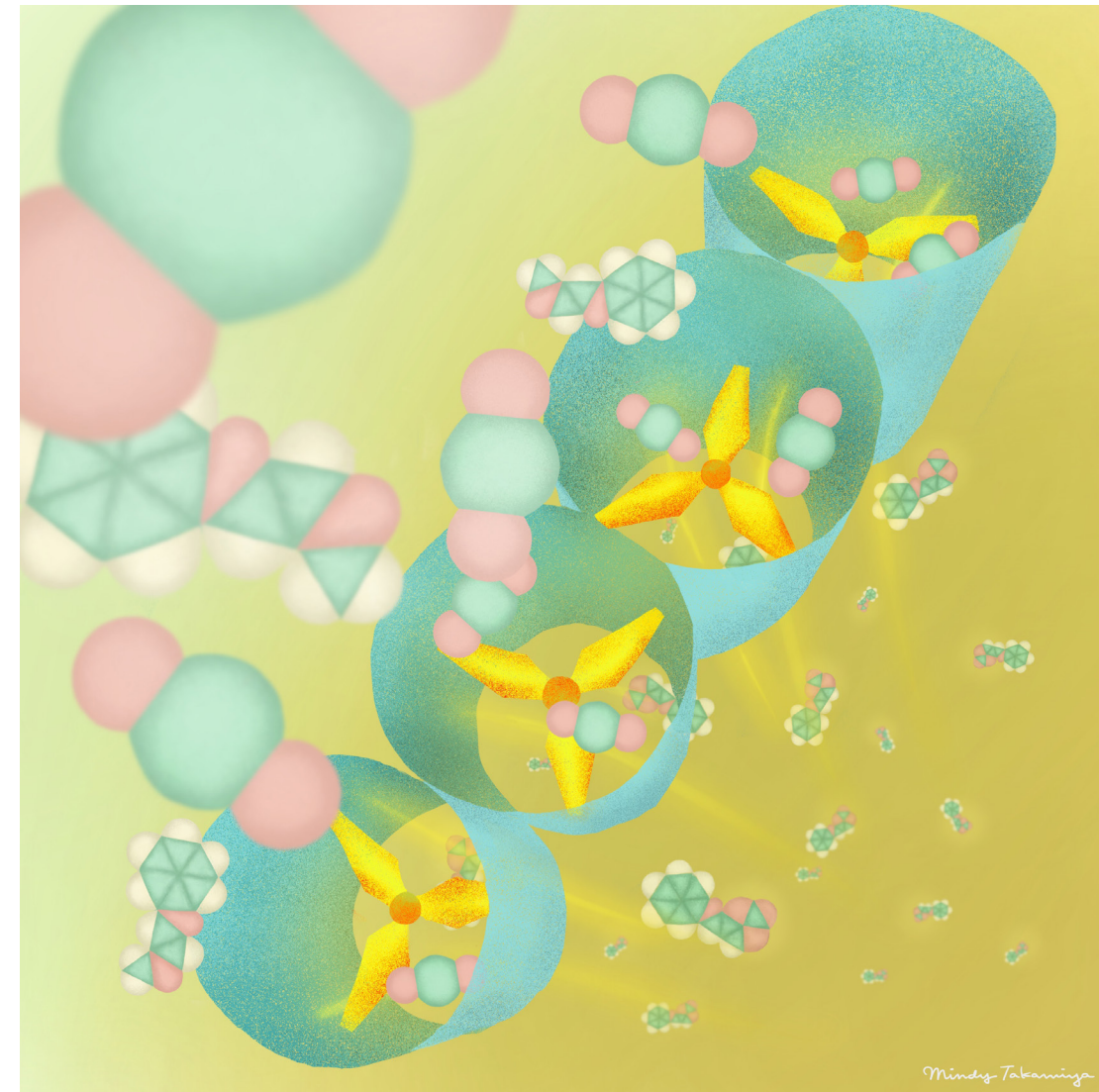
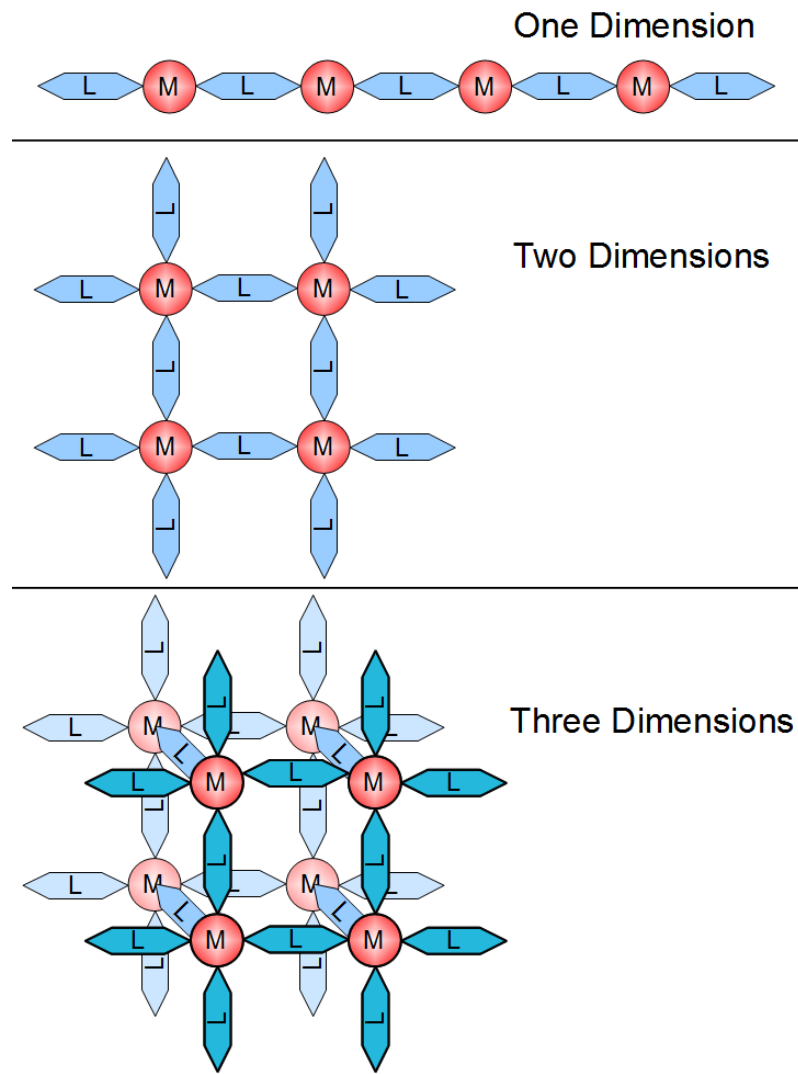

JORDAN HEDLUND
UNIVERSITY OF MINNESOTA

LA 8774
INFRASTRUCTURE 4
JESSICA ROSSI-MASTRACCI

ASSIGNMENT #3
INNOVATIVE MATERIALS

THESE DOCUMENTS, CREATED BY JORDAN HEDLUND, AND ASSOCIATED DRAWINGS, HAVE NOT BEEN REVIEWED BY A LICENSED LANDSCAPE ARCHITECT. JORDAN HEDLUND IS NOT A LICENSED LANDSCAPE ARCHITECT HIMSELF. MOREOVER, THE ATTACHED DRAWINGS HAVE BEEN CREATED BY A STUDENT UNDER THE GUIDANCE OF PROFESSIONALS AND FACULTY. DRAWINGS HAVE BEEN CREATED TO HELP GUIDE THE DESIGN PROCESS AND SHOULD BE REVIEWED BY A LICENSED LANDSCAPE ARCHITECT AND/OR CONTRACTOR PROPOSING TO CONSTRUCT WORK. IT IS ADVISED THAT NO CONSTRUCTION START UNTIL FURTHER REVIEW.

DATE: 12/10/20
VERSION: DRAFT 1

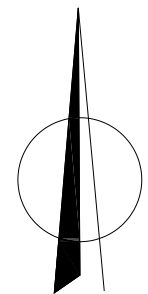

SEE SCALE
SCALED TO TABLOID

BACKGROUND

Inspiration for this project came from Collin Wenberg's project "To Imbue Resurgence". In this project (fig.1 & 2) he proposed the construction of different styles of walls, latices, and vertical posts to promote vine growth. Each variety of vine grows differently and requires certain types of structures to climb.

This material is being proposed for the North Minneapolis Technical Workforce Center. At the center, students will study the performance of the material as a structure for both indoor and outdoor vine growth. Beyond that, the performance of the material and structure system will hopefully create a foundation for further research about the emerging technology.

The process shown in Fig. 3 shows how the structure would act in the overall life cycle. The process would be to deconstruct the assembly, remove epoxy from the individual pieces, remove carbon from epoxy, reapply epoxy to the pieces, then put the assembly back together.

The Polyurethane would then be collected and reused, essentially making products from thin air. Some of these products could be polyester for clothing, to foams, to shoes. ***In theory, once enough polyurethane is generated from the first model, it could be used to manufacture the subsequent panels, posts, and latices.***

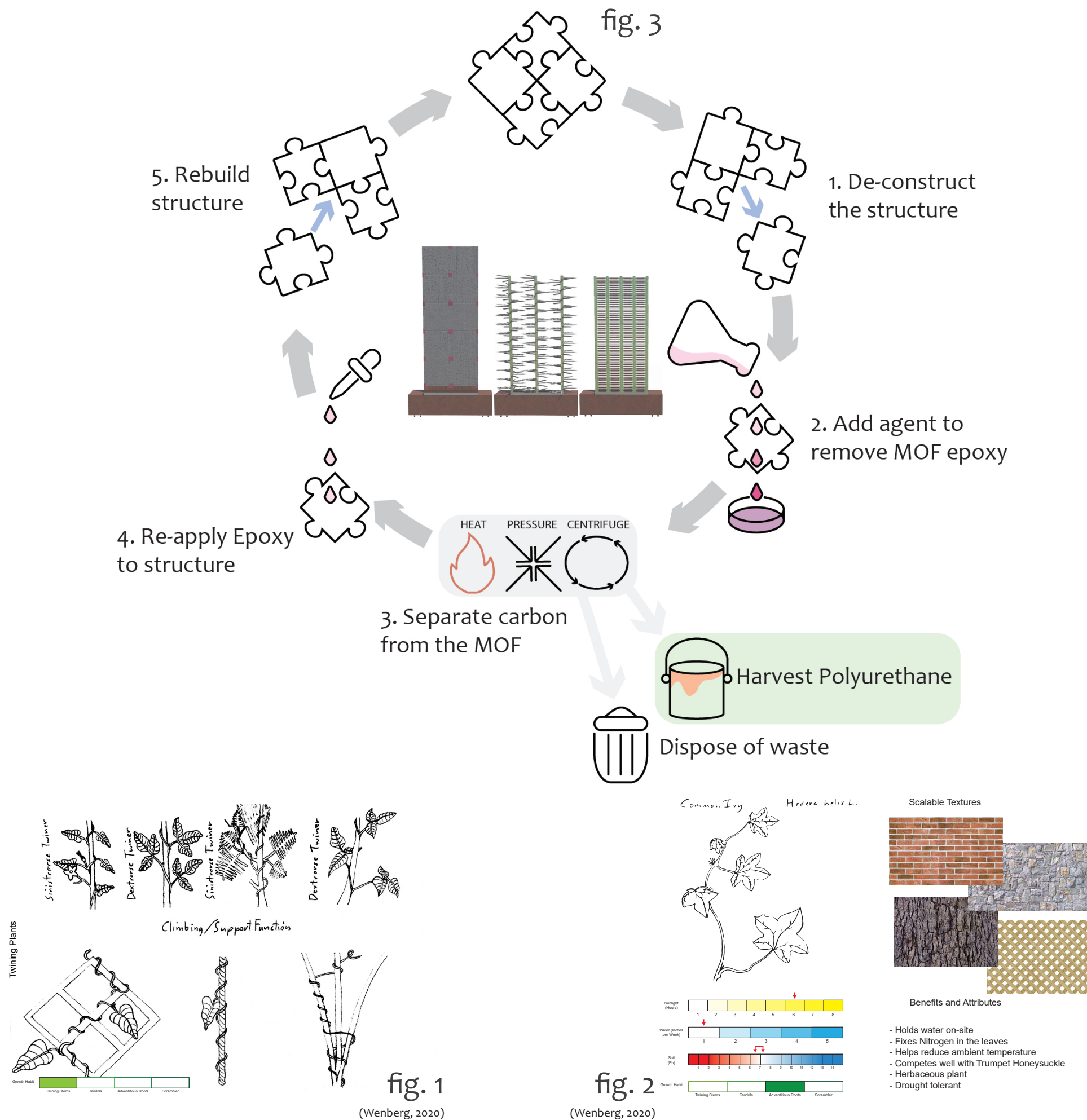

THESE DOCUMENTS, CREATED BY JORDAN HEDLUND, AND ASSOCIATED DRAWINGS, HAVE NOT BEEN REVIEWED BY A LICENSED LANDSCAPE ARCHITECT. JORDAN HEDLUND IS NOT A LICENSED LANDSCAPE ARCHITECT HIMSELF. MOREOVER, THE ATTACHED DRAWINGS HAVE BEEN CREATED BY A STUDENT UNDER THE GUIDANCE OF PROFESSIONALS AND FACULTY. DRAWINGS HAVE BEEN CREATED TO HELP GUIDE THE DESIGN PROCESS AND SHOULD BE REVIEWED BY A LICENSED LANDSCAPE ARCHITECT AND/OR CONTRACTOR PROPOSING TO CONSTRUCT WORK. IT IS ADVISED THAT NO CONSTRUCTION START UNTIL FURTHER REVIEW.

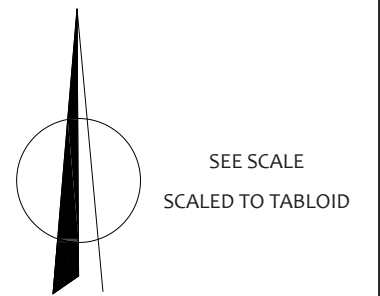

SEE SCALE
SCALED TO TABLOID

NARRATIVE

This process can then be applied to a more specific approach, like at the workforce center and for plant growth. At the center, students and workers would construct and deconstruct different types of lattice, post, and panel assemblies. The assemblies would either have a footer mounted base or be modular on wheels to be moved around the site. By doing this, research can be gathered on whether assemblies gather more CO₂ closer to roads, impact of the plant growth on CO₂ harvesting, and the impact of the MOF on the plant's growth.

Due to the recyclability of the material, the studies can be done over and over again in many different situations. The idea of "Capture, Concentrate, Convert" can be taught in real time. Though the research to this point has yet to scale up to, the potential when it eventually does is huge.

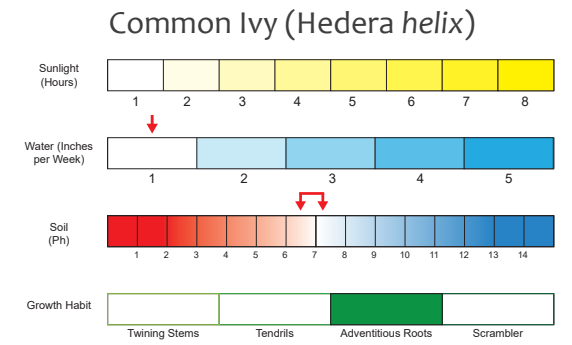
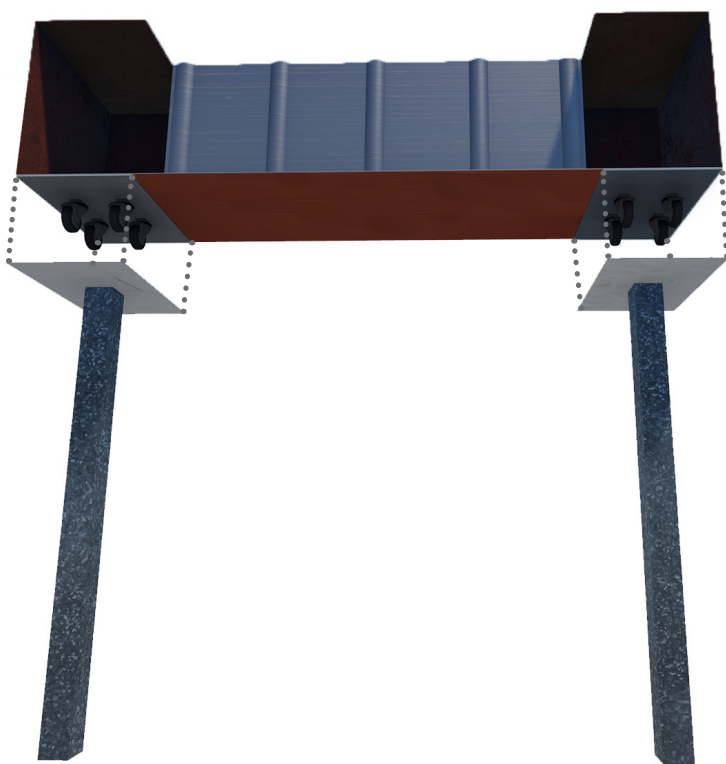

(Wenberg, 2020)
2' square panels easily (de)construct with a standard plate and bolt system.

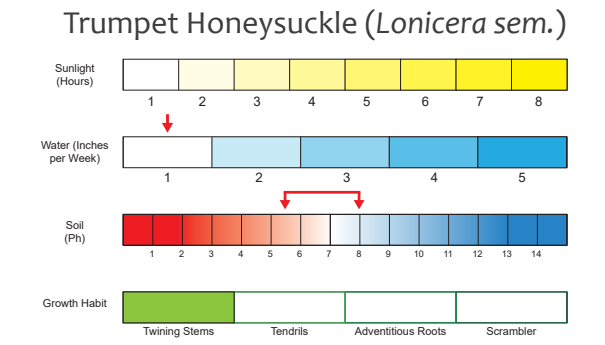

(Wenberg, 2020)
12" long dowels (un)screw and are spaced 1" apart for optimal plant tendril attachment.

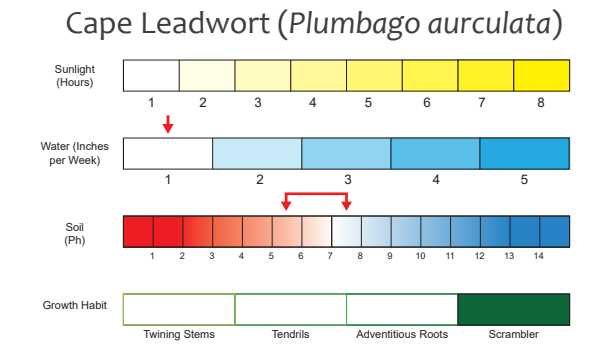
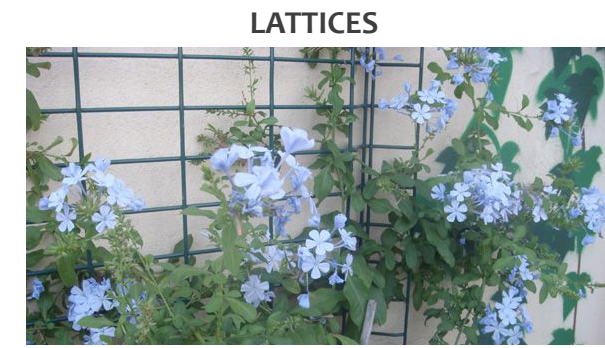
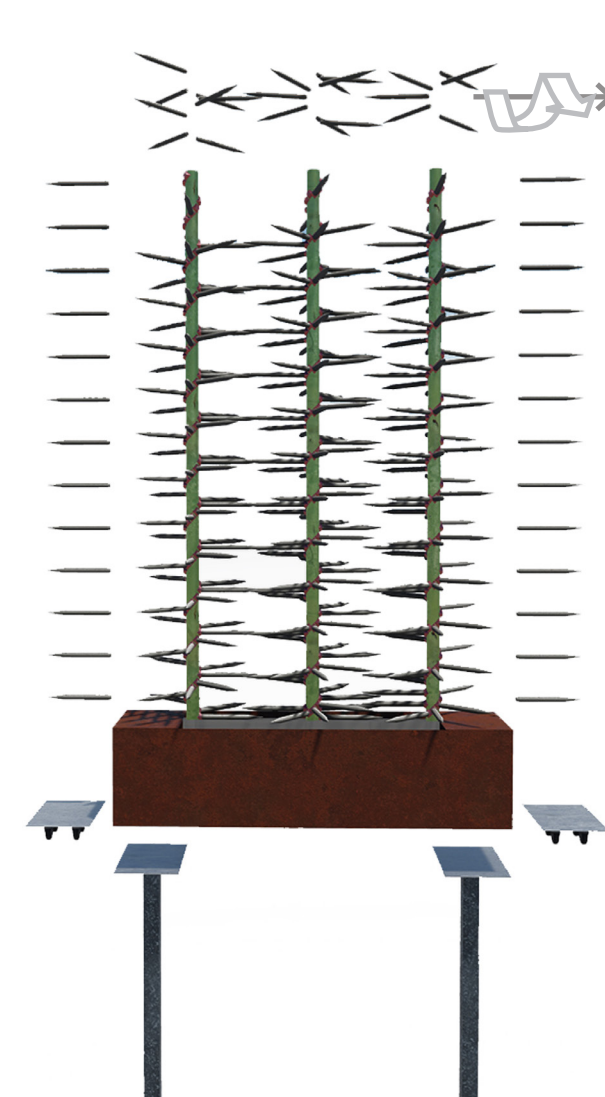

(Wenberg, 2020)
Lattice slats slide up and out, and are spaced 1" apart for scrambling vine growth.

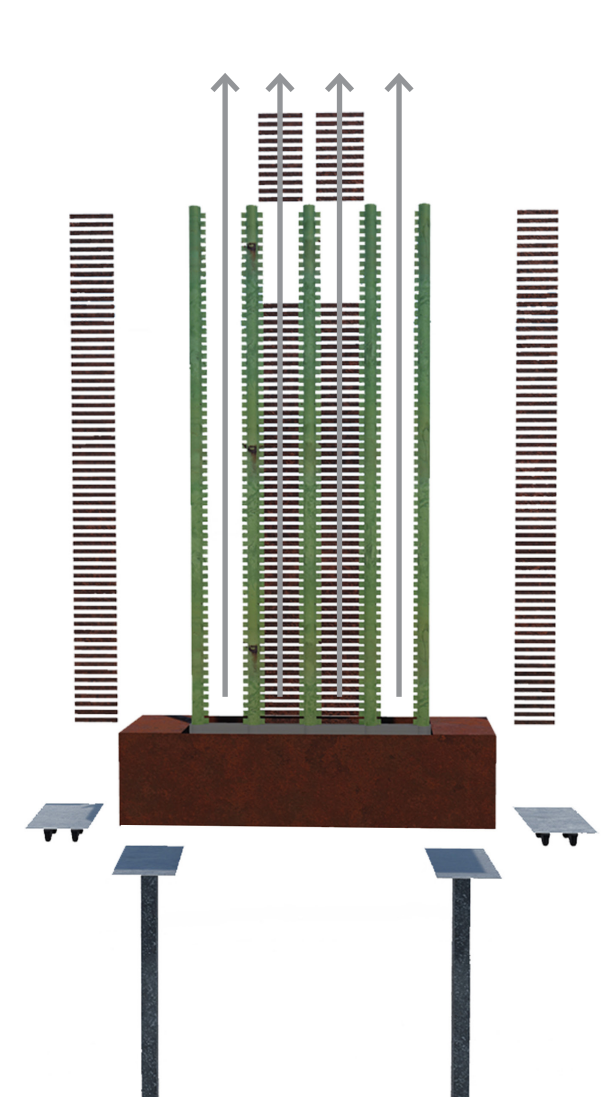

THESE DOCUMENTS, CREATED BY JORDAN HEDLUND, AND ASSOCIATED DRAWINGS, HAVE NOT BEEN REVIEWED BY A LICENSED LANDSCAPE ARCHITECT. JORDAN HEDLUND IS NOT A LICENSED LANDSCAPE ARCHITECT HIMSELF. MOREOVER, THE ATTACHED DRAWINGS HAVE BEEN CREATED BY A STUDENT UNDER THE GUIDANCE OF PROFESSIONALS AND FACULTY. DRAWINGS HAVE BEEN CREATED TO HELP GUIDE THE DESIGN PROCESS AND SHOULD BE REVIEWED BY A LICENSED LANDSCAPE ARCHITECT AND/OR CONTRACTOR PROPOSING TO CONSTRUCT WORK. IT IS ADVISED THAT NO CONSTRUCTION START UNTIL FURTHER REVIEW.

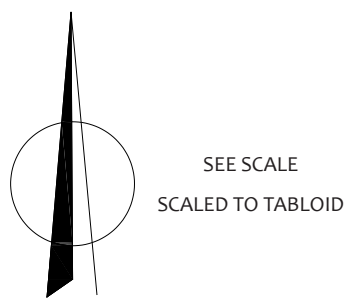

SEE SCALE
SCALED TO TABLOID

(De)Assembly

The materiality of this product is meant to be durable, sustainable, and easy to (de)construct. The base options are either a direct bury footer or a wheel system, both standardized to easily attach to the underside of the planter box. The interior corten steel welded sleeve and panels come already attached and the customer can interchange the 3 systems: **panels**, **posts**, or **lattice**. The first version would be made out of molded HDPE, but after enough cycles of the system the polyurethane could be collected to potentially mold future models. All molds must have a maximum FEPA grit rating of P12-P36 to allow for the plant's own tendril attachments.

The **panel system** has a steel sleeve that bolts into the base prior to filling with soil. The 10 panels then attach via 16 steel plates and through-bolts.

The **post system** comes with 3 posts that sit in the round sleeves and are bolted into place at the base. Then the 312 spindles (un)screw interchangeably on any post in any location.

The **lattice system** consists of 5 posts (2 ends, 3 middles) that have grooves for 252 lattice slats to drop into. Each row has 63 slats and gravity holds them in place.

Each system gets filled with 18" of potting soil after it is built for the first time, and the corresponding Ivy, Honeysuckle, or Leadwort get planted. Small weep holes are drilled into the base of the box for water drainage and the planter should be oriented so that it drains in the back.

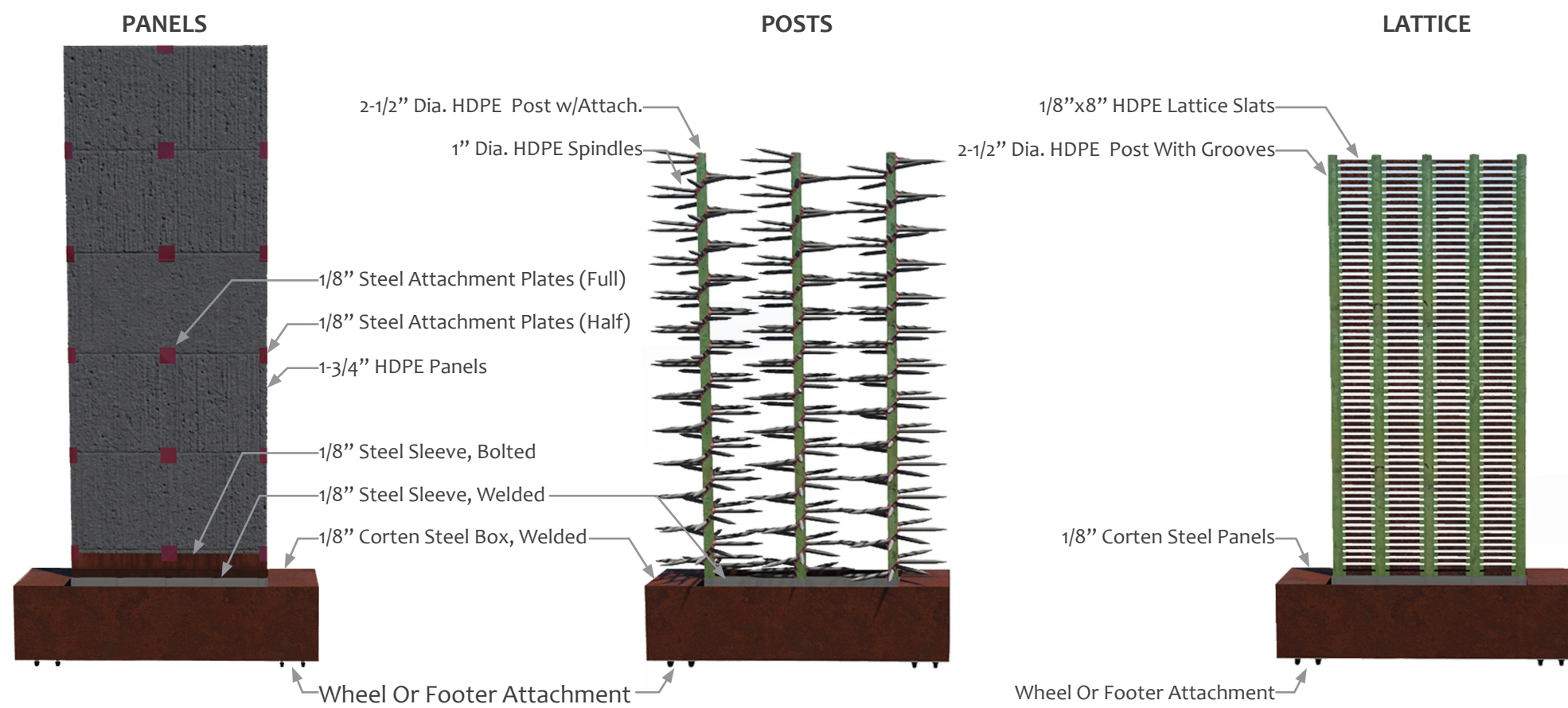

THESE DOCUMENTS, CREATED BY JORDAN HEDLUND, AND ASSOCIATED DRAWINGS, HAVE NOT BEEN REVIEWED BY A LICENSED LANDSCAPE ARCHITECT. JORDAN HEDLUND IS NOT A LICENSED LANDSCAPE ARCHITECT HIMSELF. MOREOVER, THE ATTACHED DRAWINGS HAVE BEEN CREATED BY A STUDENT UNDER THE GUIDANCE OF PROFESSIONALS AND FACULTY. DRAWINGS HAVE BEEN CREATED TO HELP GUIDE THE DESIGN PROCESS AND SHOULD BE REVIEWED BY A LICENSED LANDSCAPE ARCHITECT AND/OR CONTRACTOR PROPOSING TO CONSTRUCT WORK. IT IS ADVISED THAT NO CONSTRUCTION START UNTIL FURTHER REVIEW.

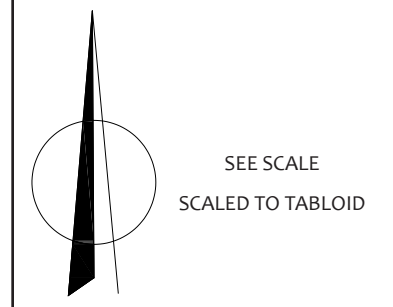

General Notes:

Always maintain a minimum of 6” between planting beds and the faces of walls, both interior and exterior.

Do not fill steel boxes with soil until structure has been fully assembled. Do not use heavy equipment to fill box or compact, shovel soil to fill.

Use compressed air to clean grooves, slots, and threads before assembling.

Wheel Option Notes:

Always lock wheels when not in use or moving.

When moving, always push/pull from steel base, never from panels, posts, or lattices. Failure to do so may damage the system and cause it to fail.

Never set planter, even locked, on sloped surfaces. Finished grades should never exceed 2%.

If using inside, plug weep holes or roll onto a mat to collect water runoff.

Footing Option Notes:

Ensure proper footer depth prior to pouring concrete. Footing post depth may vary depending on local frost depths.

Prior to pouring footings, check to ensure that the steel box is level and plum in all directions.

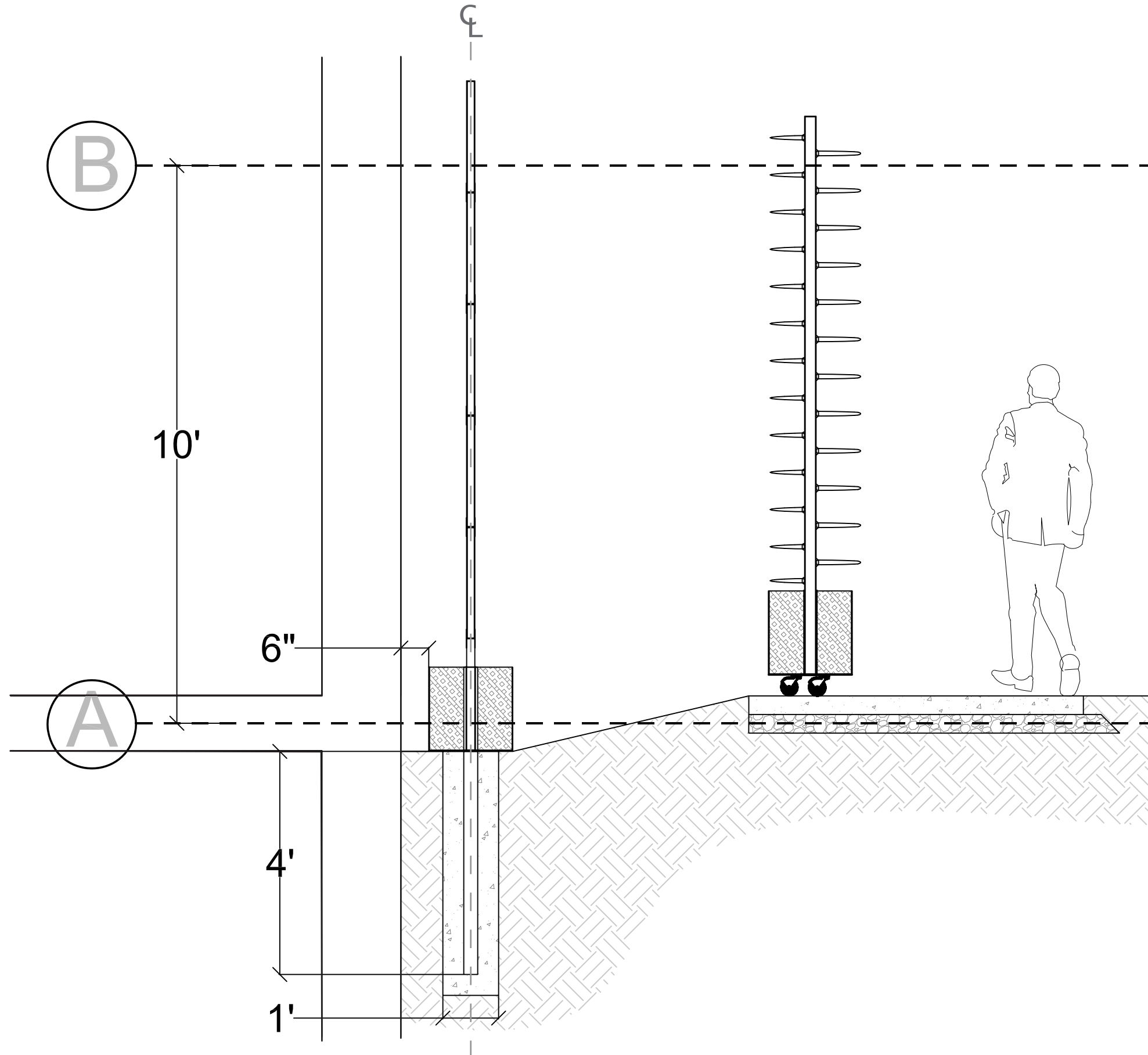

01 SECTION ASSEMBLY
05 1/2" = 1'

THESE DOCUMENTS, CREATED BY JORDAN HEDLUND, AND ASSOCIATED DRAWINGS, HAVE NOT BEEN REVIEWED BY A LICENSED LANDSCAPE ARCHITECT. JORDAN HEDLUND IS NOT A LICENSED LANDSCAPE ARCHITECT HIMSELF. MOREOVER, THE ATTACHED DRAWINGS HAVE BEEN CREATED BY A STUDENT UNDER THE GUIDANCE OF PROFESSIONALS AND FACULTY. DRAWINGS HAVE BEEN CREATED TO HELP GUIDE THE DESIGN PROCESS AND SHOULD BE REVIEWED BY A LICENSED LANDSCAPE ARCHITECT AND/OR CONTRACTOR PROPOSING TO CONSTRUCT WORK. IT IS ADVISED THAT NO CONSTRUCTION START UNTIL FURTHER REVIEW.

DATE: 12/10/20
VERSION: DRAFT 1

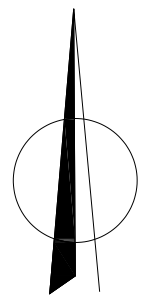

SEE SCALE
SCALED TO TABLOID

Section Assembly

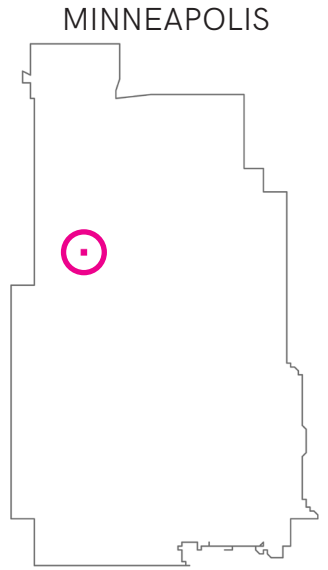
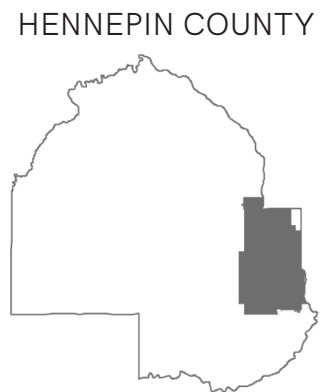
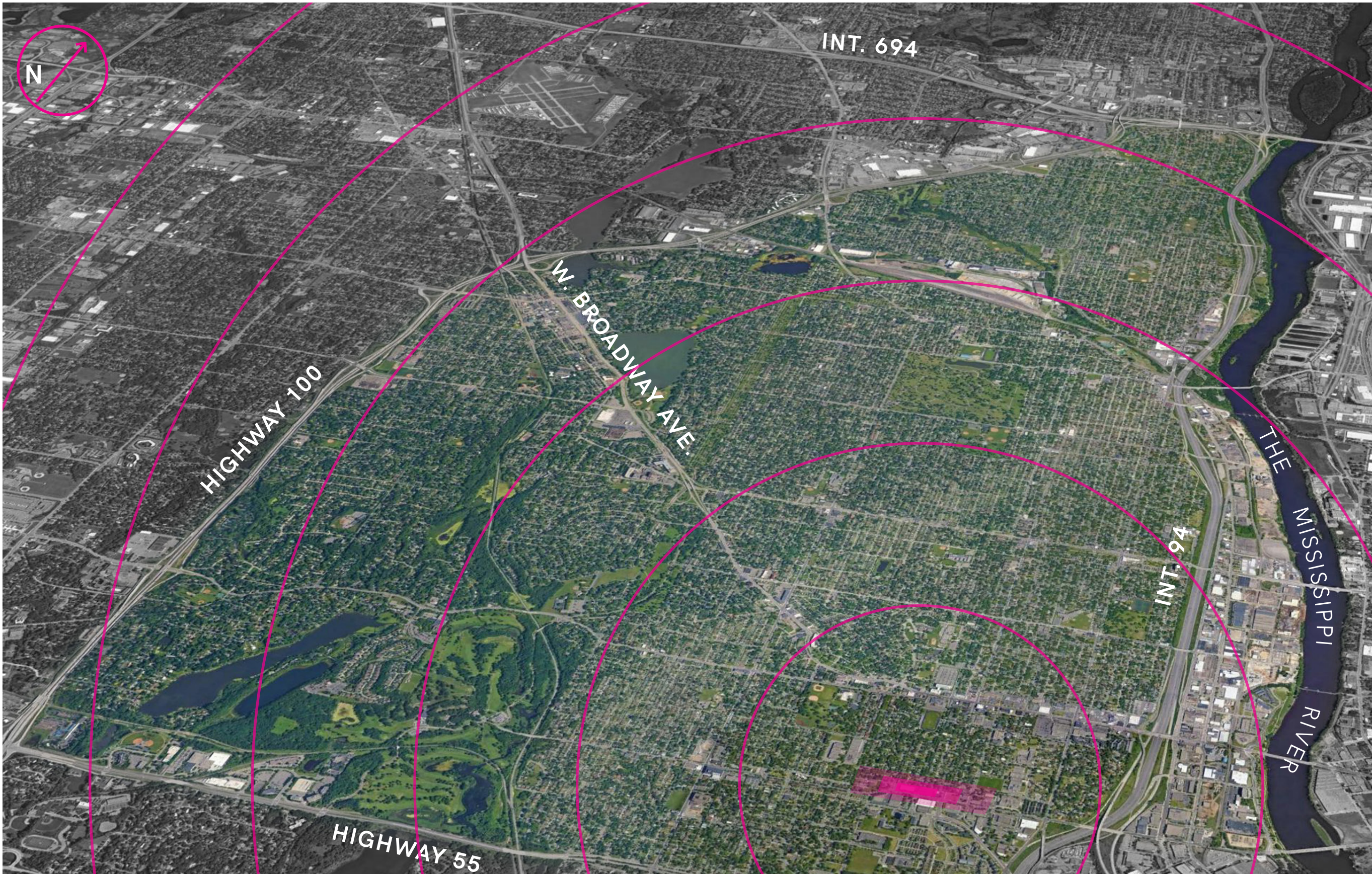

NORTH MINNEAPOLIS WORKFORCE CENTER
 1112 PLYMOUTH AVENUE

1
 Creation of
 Zinc MOF and
 epoxy.

2
 Build life size
 prototype.

3
 Test and
 Research on
 site.



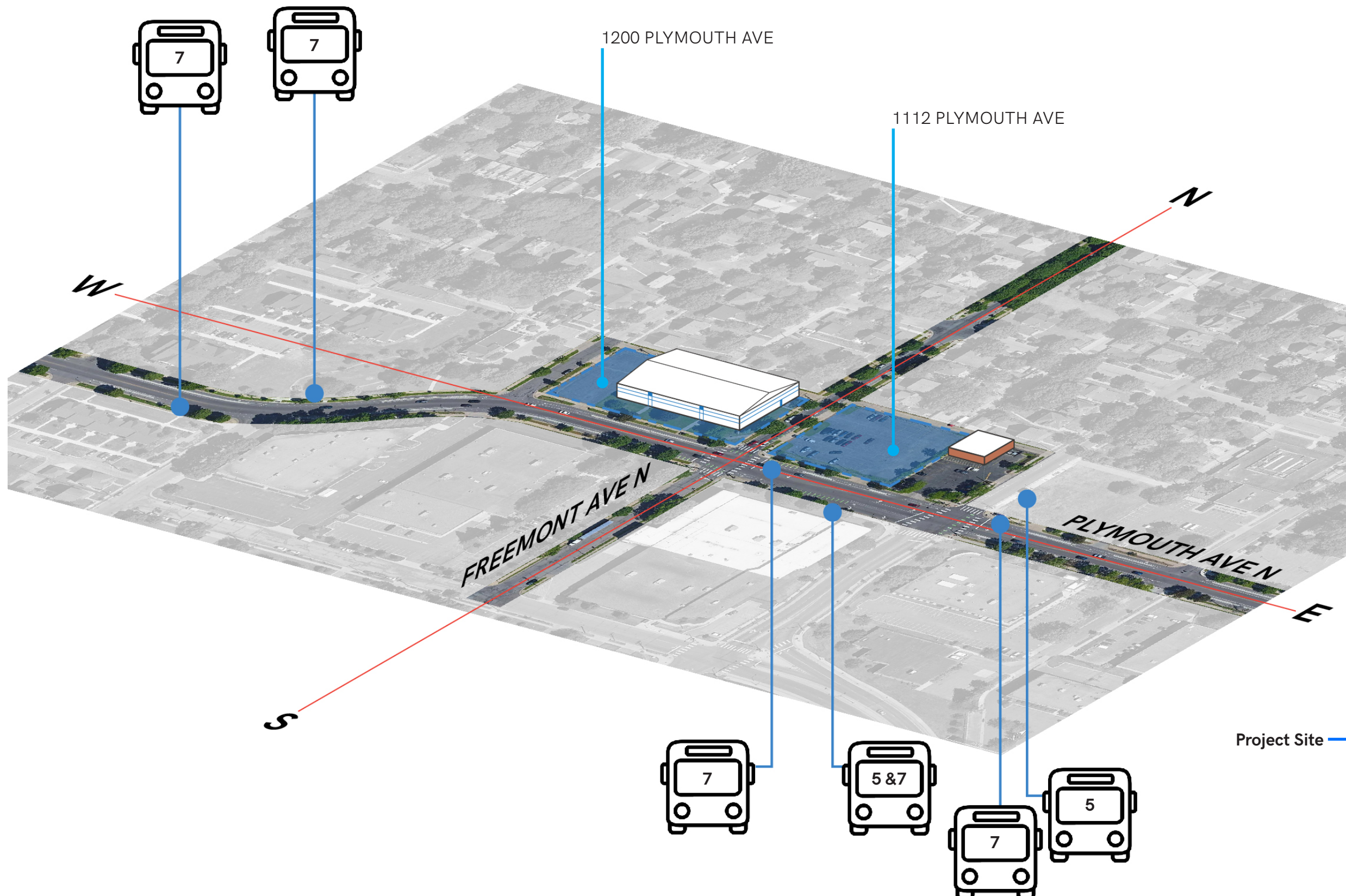

1200 PLYMOUTH AVE:

0.99 Acres

1112 PLYMOUTH AVE:

0.72 Acres

31,448 sqft Surface Parking

Bus Routes:

#5 - Connects Brooklyn Center to
Bloomington via:

- North Minneapolis
- Downtown Minneapolis
- Chicago Avenue Corridor

#7 - Connects Golden Valley to
the MSP Airport in Bloomington
via:

- North Minneapolis
- Downtown Minneapolis
- Minnehaha Corridor

Proposed RTL D-Line in 2021

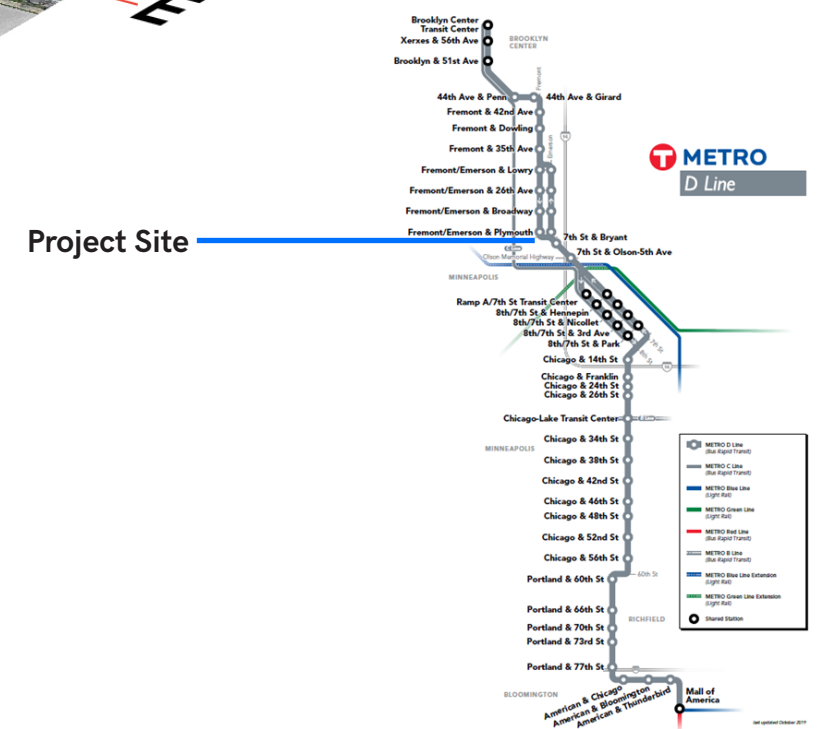

PROJECT LOCATION & TRANSIT

1112 PLYMOUTH AVENUE

CLIMATE

- ROAD GRID
- FOCUS AREA
- RUNOFF POTENTIAL
- LOCALIZED FLOODING
- FEMA FLOODWAY
- FEMA 100 YR FLOOD
- FEMA 500 YR FLOOD
- LOCALIZED TEMPERATURES
- LOW
-
- HIGH

Project Site

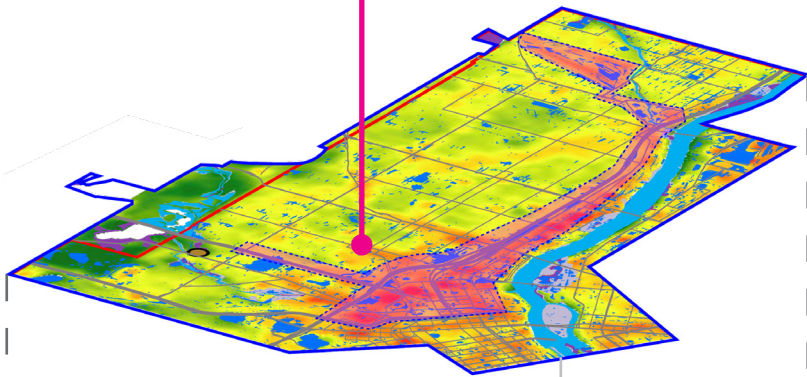

Capture & Decentralize Water Corridor

Re vegetate Canopy Corridor

Project Site

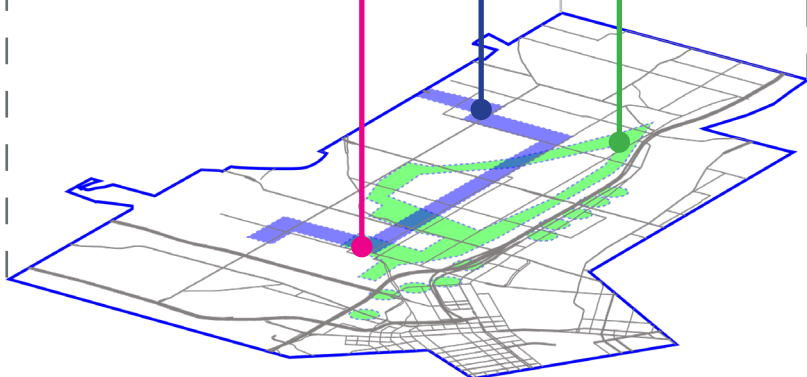

HABITAT

- ROAD GRID
- FOCUS AREA
- BROKEN PARK CONNECTIONS
- PARKLAND
- EXPANDED POLLINATOR HABITAT SUITABILITY
- LOW
-
- HIGH

Project Site

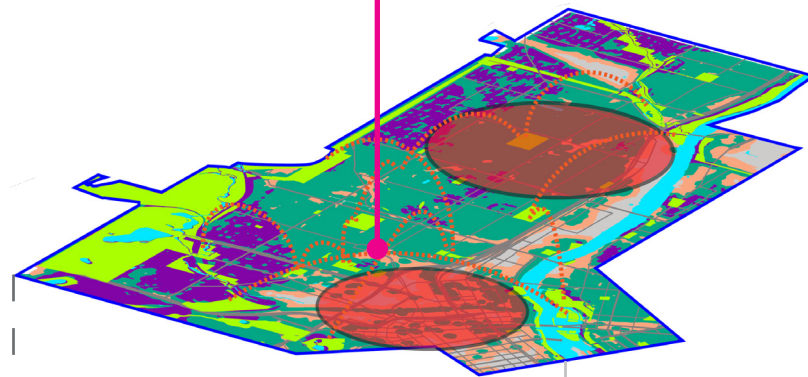

Habitat in Boulevards Corridors

Habitat in Industrial Zone Corridor

Project Site

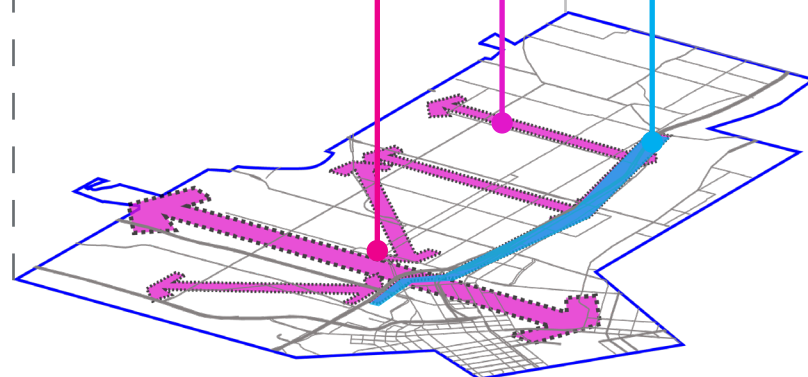

COMMUNITY

- ROAD GRID
- FOCUS AREA
- INTERSTATE HIGHWAYS
- PARKLAND
- WATERWAYS
- INDUSTRIAL/UTILITY LANDUSE
- ★ PERMIT TO POLLUTE BUSINESS
- INCOME
- LOW
-
- HIGH

Project Site

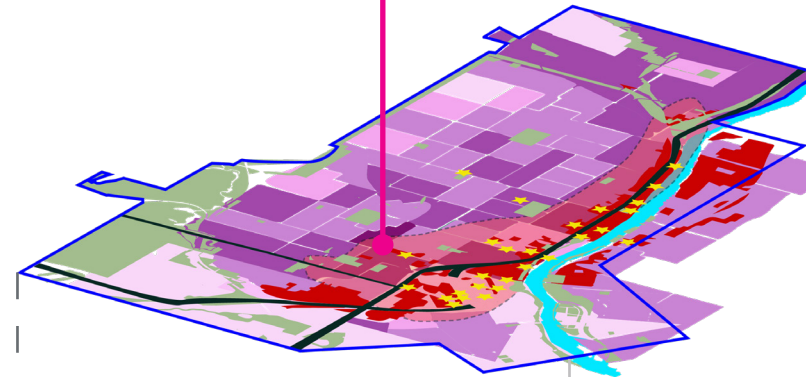

Parkland Accessibility Corridors

Access & Equity

Project Site

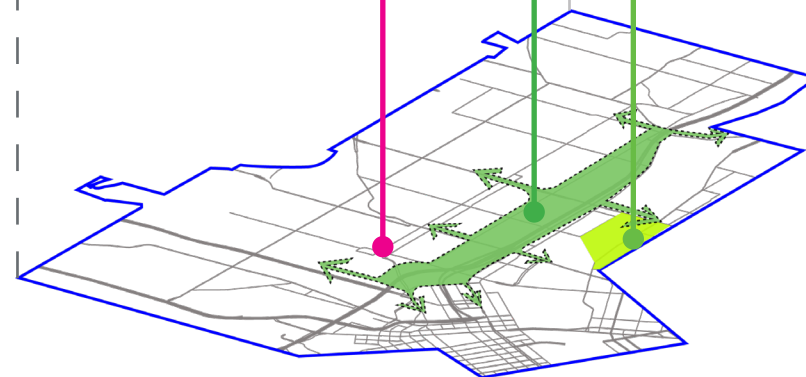

The corridor planning and assessment for the North Minneapolis region shows many things. Through analysis of the layers voids throughout the city begin to emerge. Voids showing reduced tree canopy and reduced pervious surfaces. Also, the loss of pollinator and bird habitat create large vacant “dead” spaces. Finally, reduced access to the Mississippi River and concentrations of permits to pollute in low income areas.

By overlapping layers of information a few key concepts come to light creating promising corridor strategies. First is **climate** resiliency and the mitigation of heat island and storm water run off. Second is the need for increased **habitat** that connect suitable areas of the city as we as returning industry to nature. Third is to ensure equal **community** access to nature and healthy environments throughout the city.

N FREEMONT AVE



PLYMOUTH AVE N

EXISTING SITE

1112 PLYMOUTH AVENUE

1:20

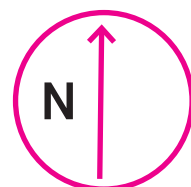

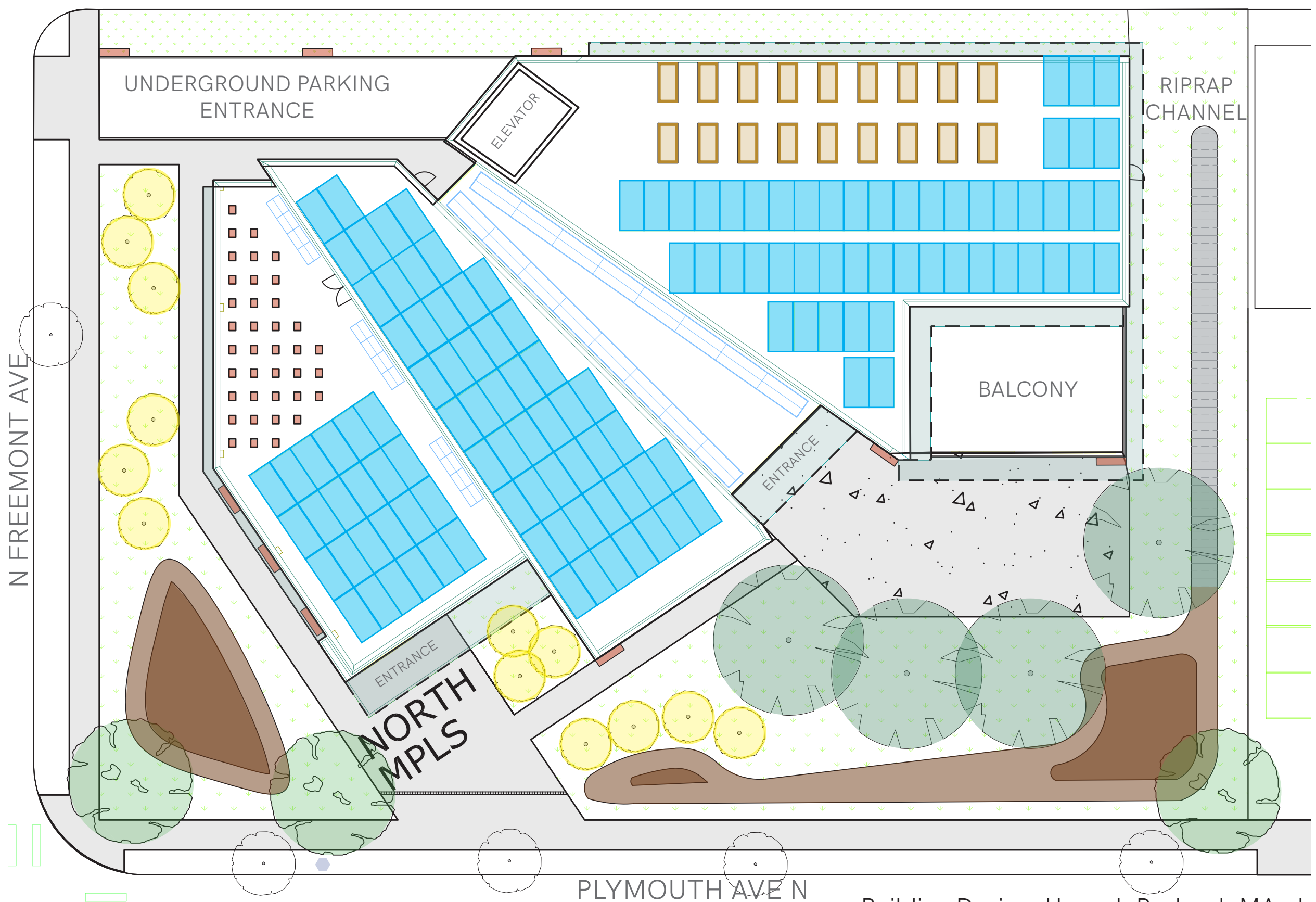

Location of MOF planters

N FREEMONT AVE

RIPRAP CHANNEL

BALCONY

ENTRANCE

ENTRANCE
NORTH MPLS

PLYMOUTH AVE N

Building Design: Hannah Packard, MArch

PROPOSED SITE PLAN

1112 PLYMOUTH AVENUE

1:20

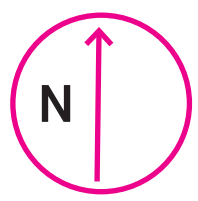



PARKING ENTRY ON N. FREEMONT AVE

1112 PLYMOUTH AVENUE



1200 PLYMOUTH VIEW FACING EAST

1112 PLYMOUTH AVENUE

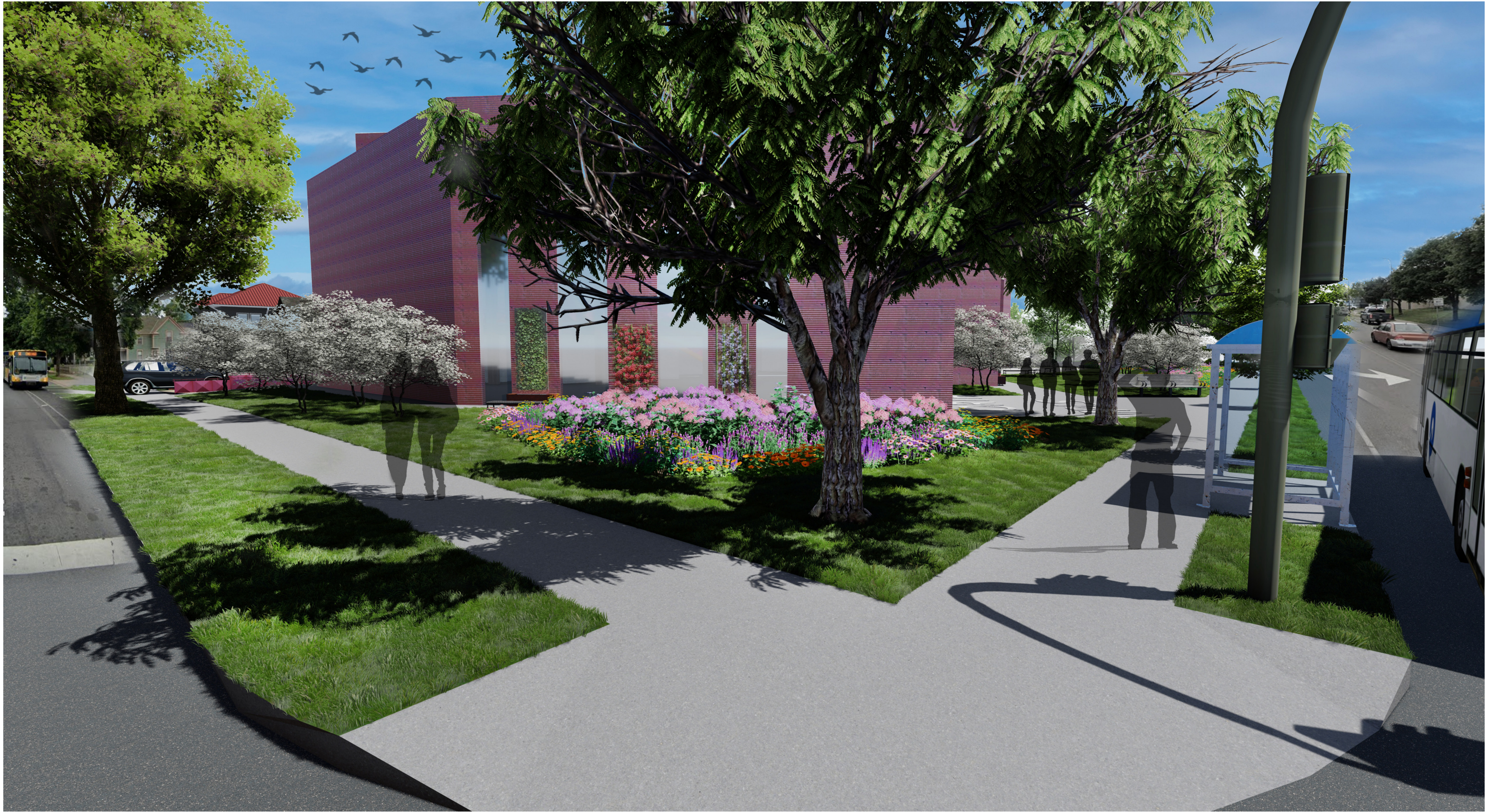

VIEW FROM BUS STOP

1112 PLYMOUTH AVENUE



VIEW FROM THE EAST

1112 PLYMOUTH AVENUE



MAIN ENTRANCE

1112 PLYMOUTH AVENUE